



YTTERPANEL

## YTTERPANEL

Vi tillverkar ytterpaneler av finkvistig gran som levereras obehandlad eller ytbehandlad. Den ytbehandlade ytterpanelen målas två gånger, en grund- och en mellanstrykning i valfri kulör. Vi erbjuder färgsystem som alkyd, akrylat och slamfärg.

Ytterpanelerna är klara för montering, dock ska en sista toppfärg strykas på inom 12 månader. Produkterna kan bearbetas, bland annat utförs exaktkapning och fingerskarvning. Fingerskarvade och ytbehandlade ytterpaneler upp till 7,5 meter är en av våra specialiteter.

## ENKELFAS

Finsågadyta.

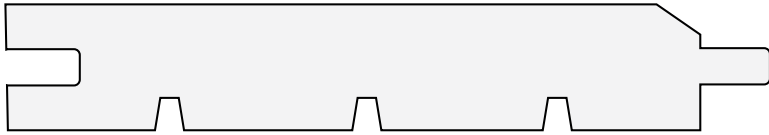

Profilnummer 78

22x95

22x120

22x145

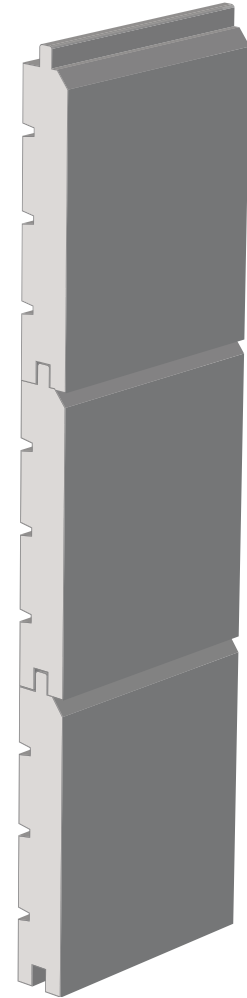

## DUBBELFAS

Finsågadyta.



Profilnummer 79

22x95

22x120

22x145

22x170

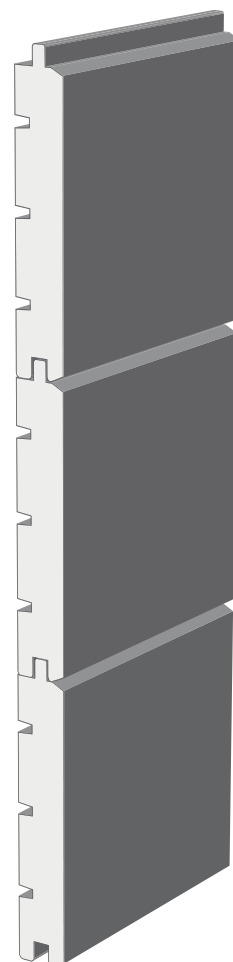

## FASPANEL

Finsågadyta.



Profilnummer 80

22 x 120

22 x 145

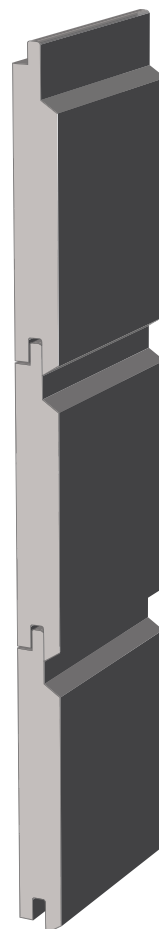

## TIMMERPANEL

Finsågadyta.

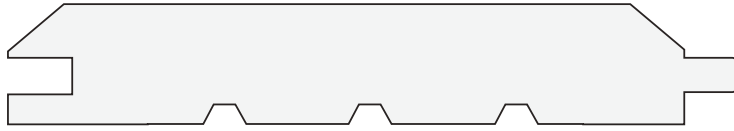

Profilnummer 77

28 x 170

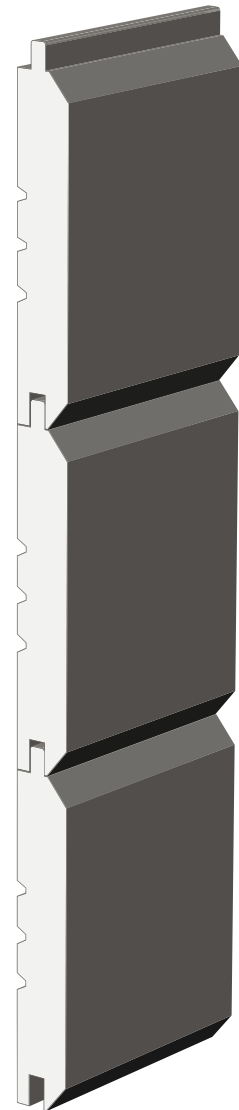

## TIMMERPANEL

Finsågadyta.

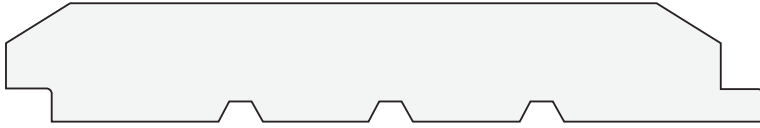

Profilnummer 75  
28x170

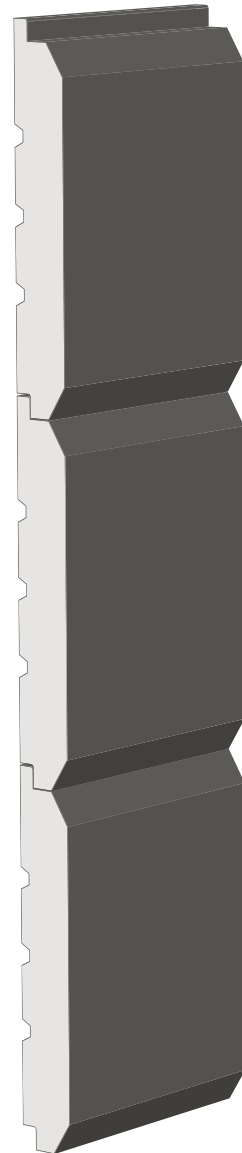

## FJÄLLPANEL

Finsågadyta.



Profilnummer 81

22 x 121

28 x 146

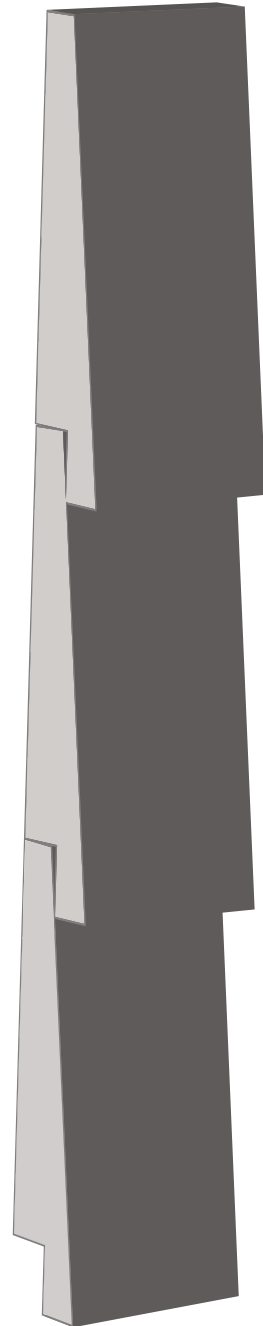



## MÄLARPANEL

Finsågadyta.



Profilnummer 105

22 x 120

22 x 145

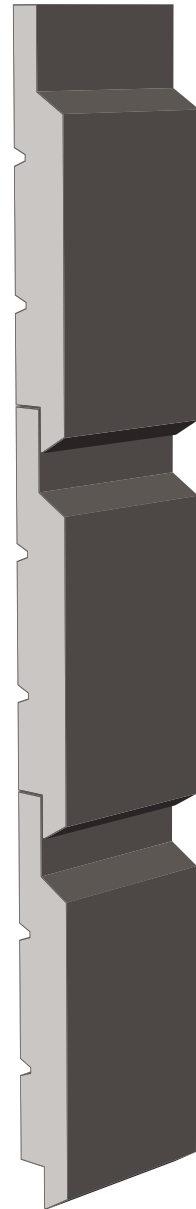

## Z-PANEL

Finsågadyta.



Profilnummer 82

22x120

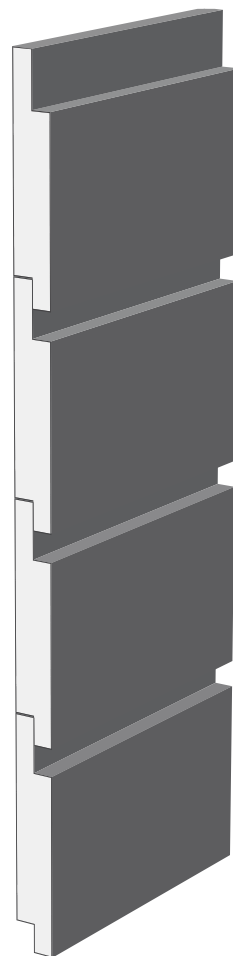

## RÅPLAN

Finsågadyta.



Profilnummer 76

22 x 70

22 x 95

22 x 120

22 x 145

22 x 170

22 x 195

28 x 145

28 x 170

28 x 195

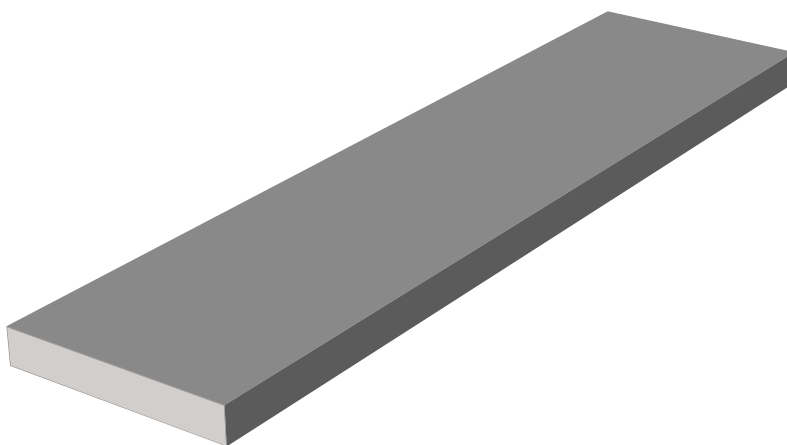

## LOCKLÄKT

Finsågadyta.



### Kälad

Profilnummer 83

17 x 45

22 x 45



### Fasad

Profilnummer 98

17 x 45

22 x 45

